

UNDERMOUNT
SLIDE SERIES

D-MOTION

D-MOTION

Soft-close and silent system

A Smooth Drawer



- DTC D-motion undermount slide, silent and soft-close
- A complete program fitting a variety of applications with soft-close, push-open, locking device and pin mount options.
- Highly stable construction, verified durability



Quietness



Intelligence



Durability



Eco-Friendliness



D-MOTION is a strong foundation for wood drawers with a smooth running action and a stable, comfortable feel.

DTC
DUAL QUALITY TECHNOLOGY

UNDERMOUNT
SLIDE SERIES
D-MOTION



Whatever the drawer size,
D-MOTION produces a smooth
running action.





Options are abundant: Locking devices or pin mount, 16-19mm drawer sides, soft-close or push-open and slide lengths for common applications. Virtually any cabinet or furniture situation can be accommodated.

DTC
— don't just buy hardware

UNDERMOUNT
SLIDE SERIES
D-MOTION



The long stroke of the soft-close dampers ensures the closing action is smooth and silent.



PRODUCT



DESCRIPTION

- Load capacity: 35kg
- Finish: zinc plated
- Length: 250-600mm
- Full extension
- Tool free assembly and removal of drawer
- Silent system guarantees smooth run without noise
- Drawer up&down adjustment: 0~+4mm
- Maximum drawer side thickness: 16mm

SPACE REQUIREMENT

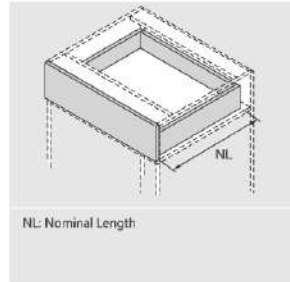

PLANNING

Installation Dimensions(mm)

NL=Nominal Slide Length LT=Internal Cabinet Depth LT=NL+3

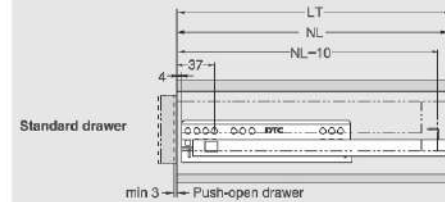

NL=Nominal Slide Length LT=Internal Cabinet Depth LT=NL+21

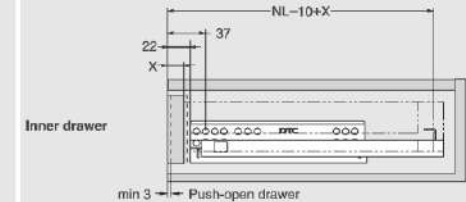

SOFT CLOSE DRAWER / PUSH-OPEN DRAWER

NL	Soft Close		Push-open	
	Item No.	Set/ctn	Item No.	Set/ctn
250mm	SS10C250H	10	FF10C250HX	6
270mm	SS10C270H	10	FF10C270HX	6
300mm	SS10C300H	10	FF10C300HX	6
350mm	SS10C350H1	10	FF10C350HX	6
400mm	SS10C400H1	10	FF10C400HX	6
450mm	SS10C450H1	10	FF10C450HX	6
500mm	SS10C500H1	10	FF10C500HX	6
550mm	SS10C550H1	10	FF10C550HX	6
600mm	SS10C600H1	10	FF10C600HX	6

Item No.	Item Name	Item No.
S/S01	Locking Pin	
HT0FH02	Rod for Push-open Synchronization /For cutting to size,1100mm.Cutting:Internal cabinet width LW-172	

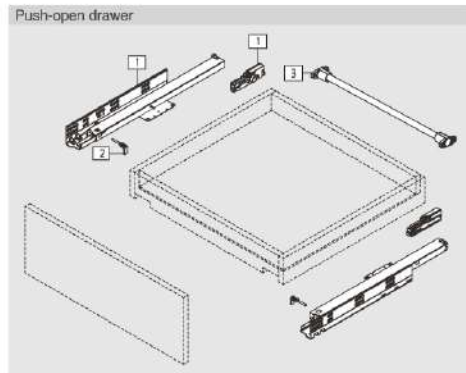
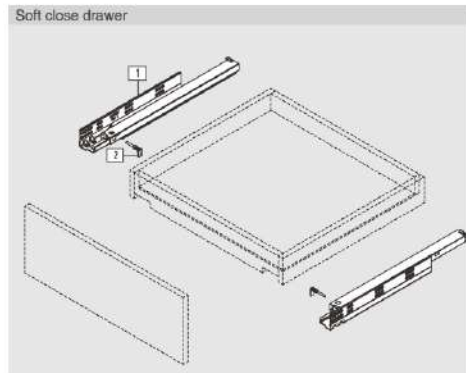

Fixing Hole Position for Inner Drawer(mm)

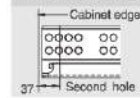

Screw Positions of the Slides(mm)

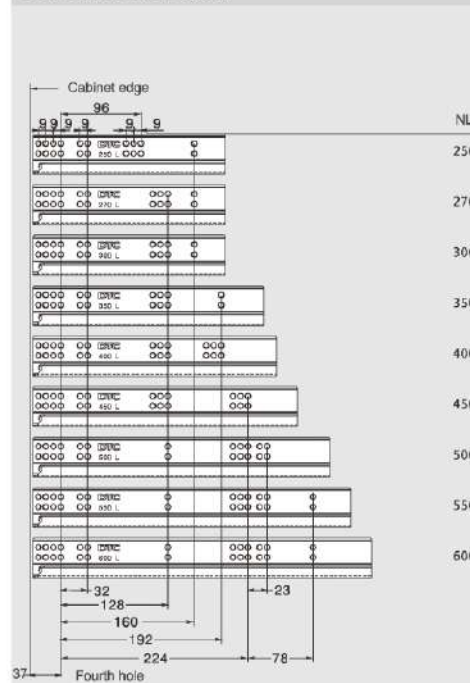

Installation Dimensions(mm)

SKW=Internal Drawer Width
LW=Internal Cabinet Width

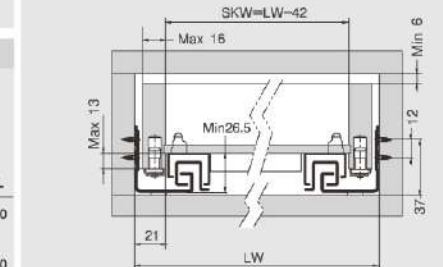

Drawer Back Preparation(mm)

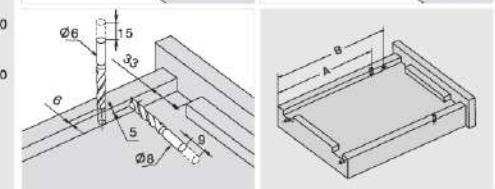
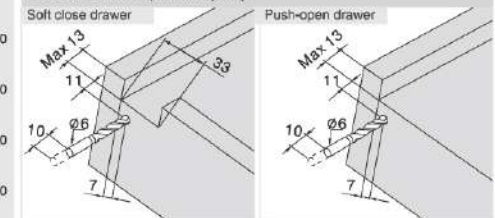

NL (mm)	250	270	300	350	400	450	500	550	600
A (mm)	190	205	245	270	305	330	355	390	415
B (mm)	200.5	215.5	255.5	280.5	319.5	369.5	419.5	469.5	519.5

ASSEMBLY AND ADJUSTMENT

Assembly and Adjustment
(for D-MOTION Full Extension Undermount Slides)



Drawer Assembly with Locking Device

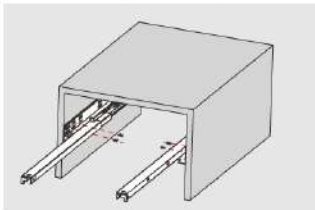

Fix the slide onto the cabinet.

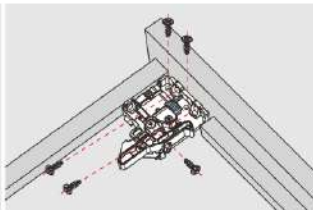

Fix the locking device onto the drawer bottom.

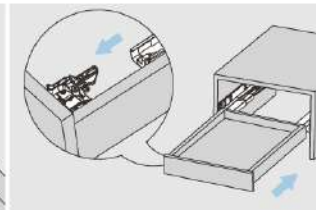

Lay the drawer bottom onto the slide then push the drawer into the cabinet.

Removal with Locking Device

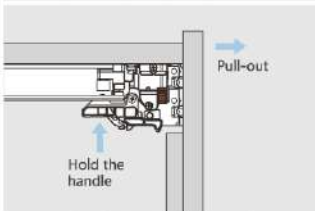

For removal, hold the handle and pull out the drawer.

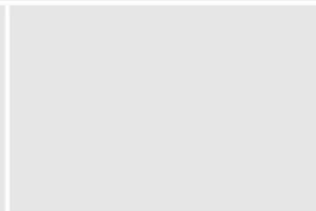
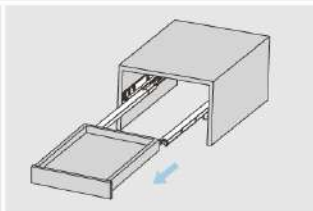

Drawer Assembly with Peg

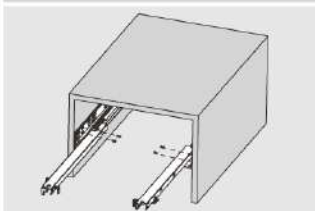

Fix the slide onto the cabinet.

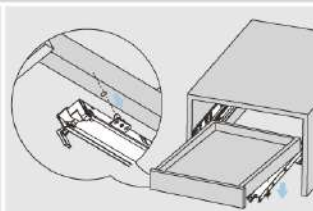

Pull out the drawer member of the slide from the cabinet, lay the drawer onto the slide.

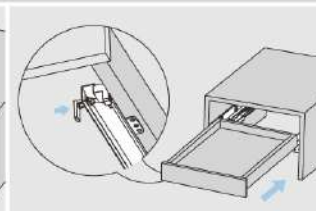

Press the locking pin into the drawer side to lock the position of the drawer.

Removal with Peg

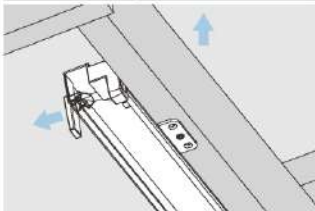

For removal, pull out the locking pin from the drawer side. Lift the drawer and pull it out from the cabinet.

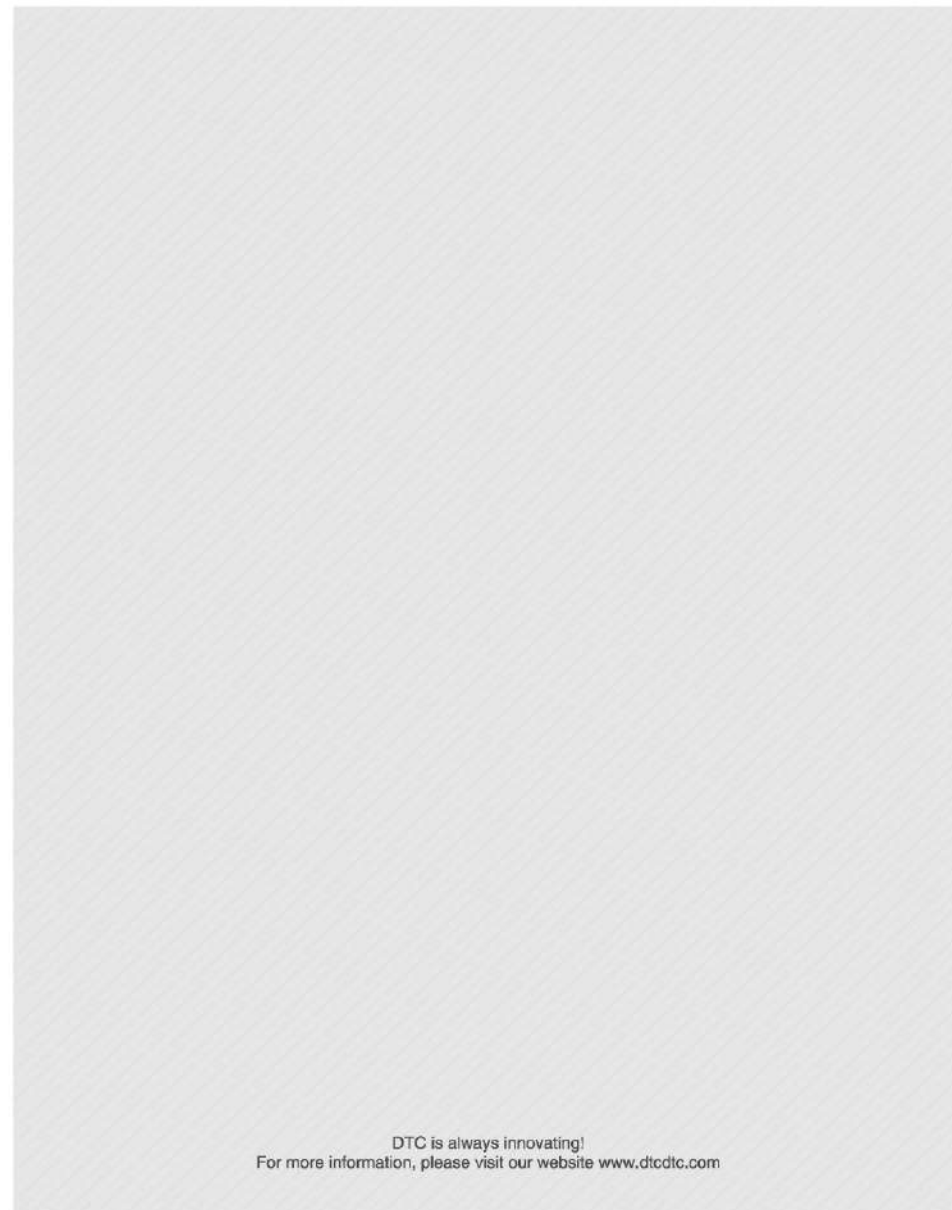

DTC is always innovating!
For more information, please visit our website www.dtcdtc.com